





1. IMPORTANT NOTES

2. INSTALL CIRCE TO THE HEATER 5

- 2.1. Open the box
- 2.2. Connect the CIRCE with the heater
- 2.3. Connect the cables
- 2.4. Close the box

3. UNINSTALL CIRCE FROM THE HEATER 8

- 3.1. Open the box
- 3.2. Disconnect the CIRCE



IMPORTANT NOTES



READ THE INSTRUCTIONS CAREFULLY BEFORE YOU USE THE ELECTRONIC THERMOSTAT.

- For any operation inside the thermostat box or on the connection box at the end of the power cable you must verify that the mains are switched off.
- This appliance is intended only for room heating. Any other use is forbidden.
- An all-pole disconnection from the supply is required, incorporated in the fixed wiring. Switches intended to ensure all-pole disconnection must be directly connected with the supply terminals and must have a contacts distance of at least 3 mm in each pole.
- You must protect the electrical line with a high sensitivity differential device.
- This appliance is intended to be connected only to 230V 50Hz AC. Check voltage type and value before installing the thermostat and respect the conventional colours:

Brown	Line Wire
Blue or Grey	Neutral Wire
Black	FIL-PILOTE Wire (open if not used)

- When the pilot wire (black wire) is not connected, safety regulations require to be insulated and no event connected to the ground.
- If the heater is in direct contact with accessible glass panels, it must not be used if the glass is damaged.
- Before connecting the power supply, check that the thermostat is completely closed and not damaged.
- Don't cut the power supply cable in order to disconnect the thermostat.
- The electrical cable cannot be repaired. If it is damaged it must be replaced by a specific one. This cable replacement must be done by a qualified professional.
- If the led fast blinks red, there is a temperature sensor fault: please contact the manufacturer.
- The apparatus must not be installed with the control box CIRCE located topside.
- Don't mount the radiator with control box CIRCE touching the floor or the wall.
- Don't mount the radiator below a power supply socket-outlet.
- The electronic thermostat is a class II apparatus and it is protected from water contact. In the bathroom it may be mounted in the zone 2 and 3 (see figure 1): CIRCE cannot be touched by person using the bath or shower.
- The electrical cable is meant to be connected to electrical system through a connection box placed behind the apparatus, without an electrical plug. The connection box must be at least 25 cm from the floor.

• INSTALL CIRCE TO THE HEATER

1.1. OPEN THE BOX

- Open the front cover. To open the box use a screw driver (3x50), insert it in to the eyelet.

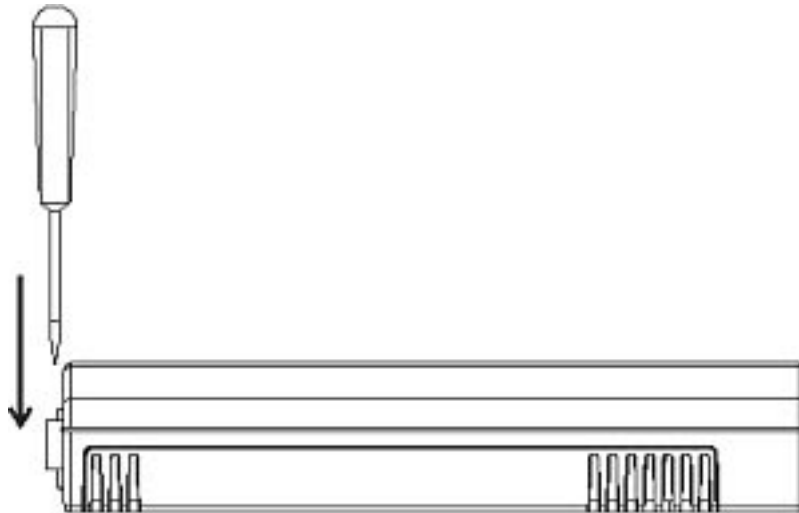

- Turn the screwdriver (A) as the following figure shows, at the same time pull the cover (B) to separate it from the base.

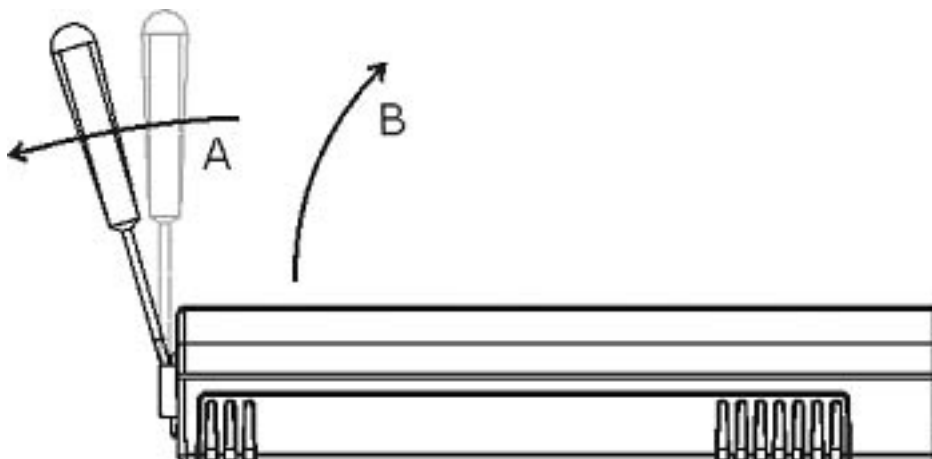

- Remove cover with a lightly rotation movement and pulling the higher part

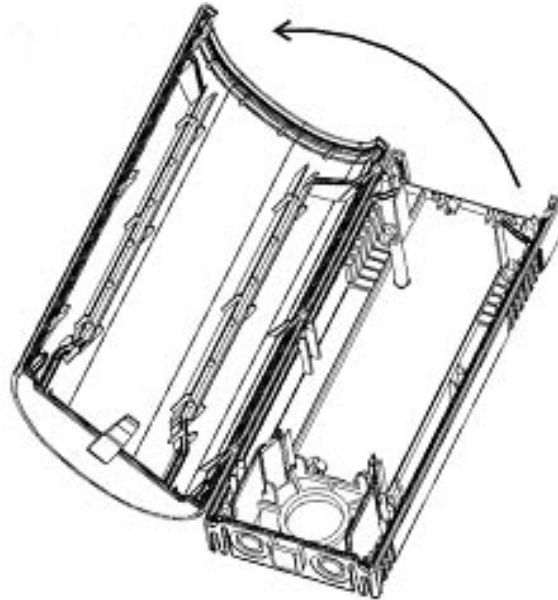

1.2. CONNECT CIRCE TO THE HEATER

- Put the rear box of CIRCE to the heater, inserting the cables of the heater's resistor in the hole of the box

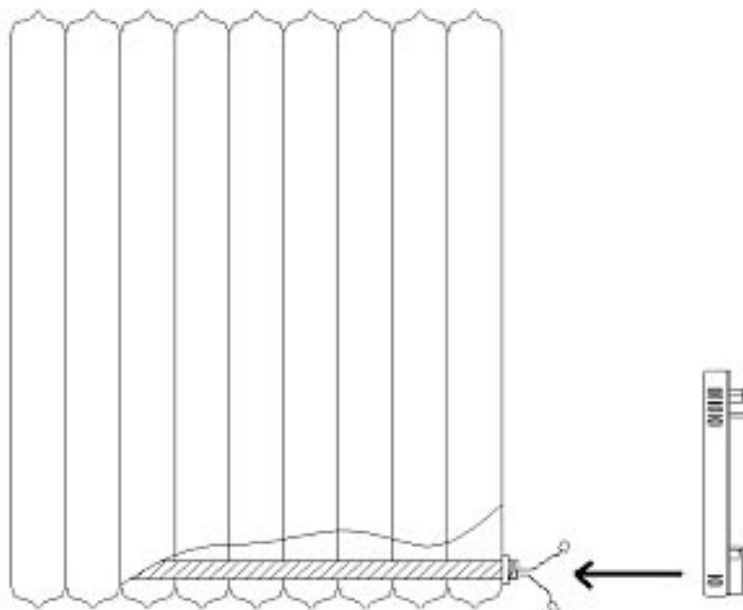

- Install the bolt using only a M27 tubular spanner, close the bolt with a minimum of 20÷25 Nm rotation strength, holding the box with a hand

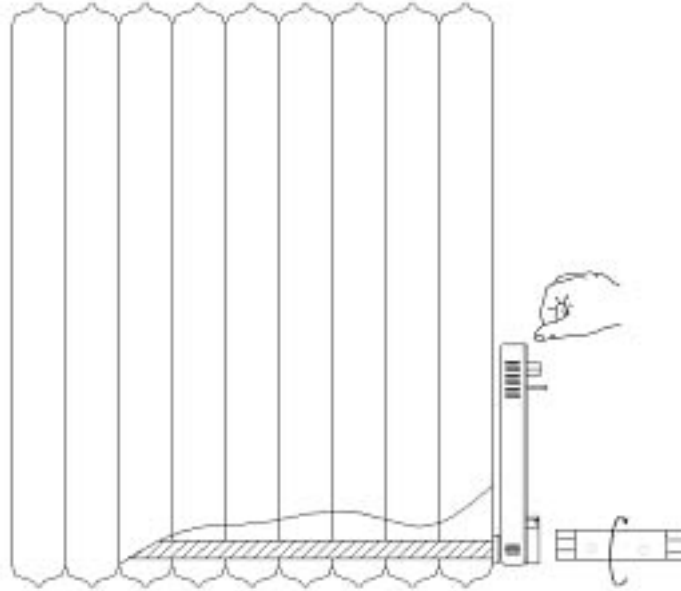

3.3. CONNECT THE CABLES

- The main power cable must not be connected. Connect the five internal faston (see the following figure).

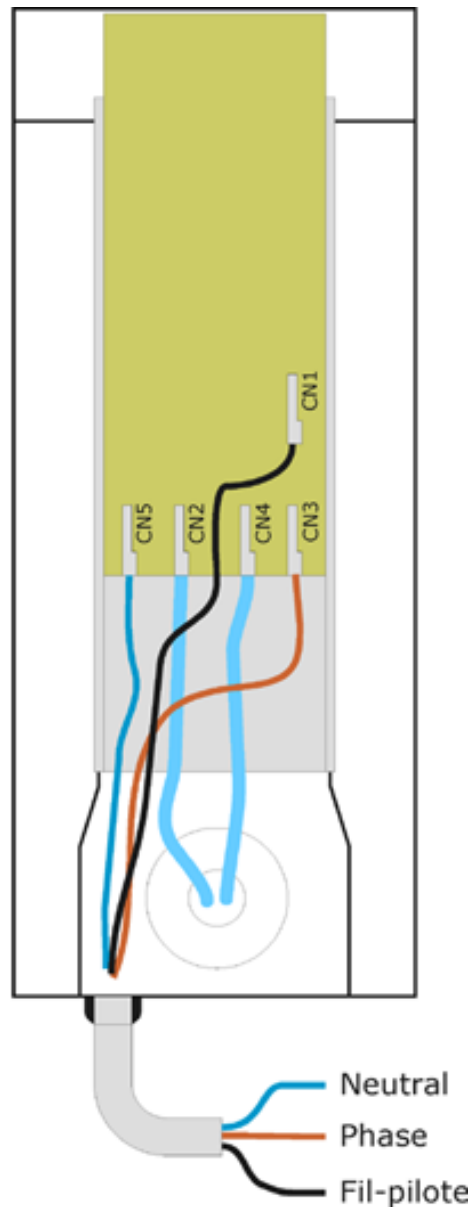

Internal connection:

FASTON ID	Connection
CN1	FIL-PILOTE (Black cable of power cord)
CN2	Heater
CN3	Phase (Brown cable of power cord)
CN4	Heater
CN5	Neutral (Blue or grey cable of power cord)

3.4. CLOSE THE BOX

- Close the box with the front cover

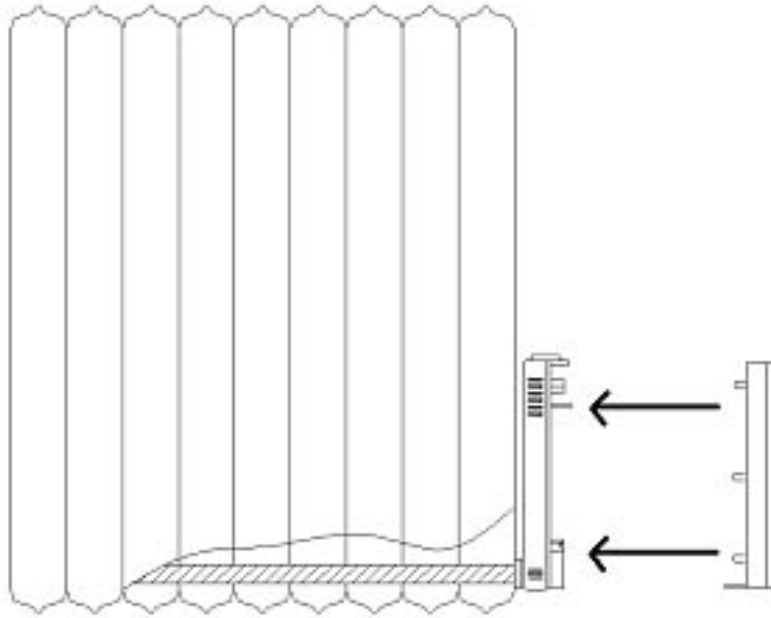

For any operation inside the thermostat box or on the connection box at the end of the power cable you must verify that the mains are switched off.

- Connect the supply cable with the main power

External cable cord connection:

Color	Connection
Blue or Grey	Neutral
Brown	Phase
Black	FIL-PILOTE - Leave open if not used -

2. UNINSTALL CIRCE FROM THE HEATER

2.1. OPEN THE BOX



For any operation inside the thermostat box or on the connection box at the end of the power cable you must verify that the mains are switched off.

- Disconnect the thermostat's cable from the main power.
- Open the front cover. To open the box use a screw driver (3x50), insert it into the eyelet.

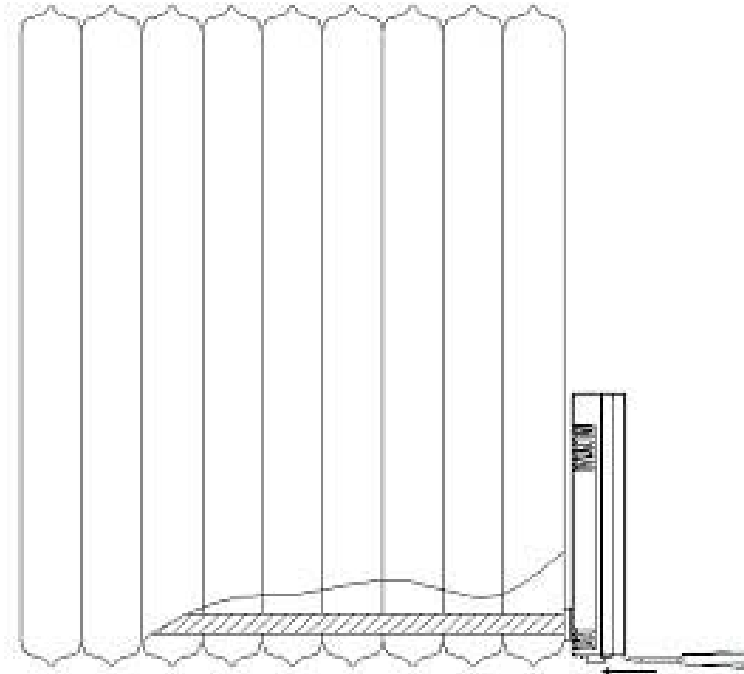

- Turn the screwdriver (A) as the following figure shows, at the same time pull the cover (B) to separate it from the base.

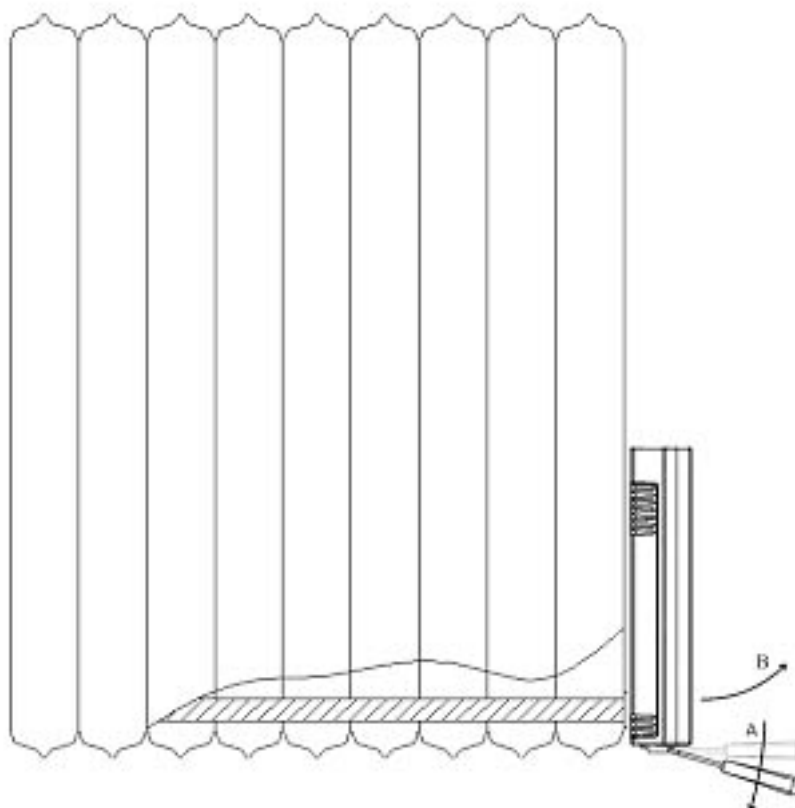

- Remove the cover with a lightly rotation movement and pulling the higher part

2.2. DISCONNECT THE CIRCE

- Disconnect the five internal faston (main power, FIL-PILOTE and heater).
- Open the bolt using only a M27 tubular spanner, holding with a hand the box of the thermostat.

